

Renvoel gebouwen

Gebouw	Naam	Vloeren	Dak	Vier	Metsel	Verkleed	Deurtype	RAVcode	Lenteprijs	Verdelersysteem	Stelsysteem	Aantal platen	Aantal deuren
1	Voorhuis	Metaalwerk/Schouwal	Geoprefibreerd staalbeton	Beton	250 m³	Mechanisch	deuren	D 2.100	-	-	traditioneel	165	165
2	Ontvangstruimte/maatstapel	Damwand	Blikken (staal)	Beton	600 m³	Natuurlijk	-	-	-	-	-	-	-
3	Garage	Metaalwerk	Geoprefibreerd staalbeton	Beton	-	Natuurlijk	-	-	-	-	traditioneel	144	144
4	Voorhuis	Metaalwerk/Schouwal	Geoprefibreerd staalbeton	Beton	160 m³	Mechanisch	deuren	D 2.3	-	-	BAL 2007.05.W	144	144
5	Toeleveringsgebouw	Metaalwerk/Schouwal	Stoffbeton	Beton	-	Natuurlijk	-	-	-	-	-	-	-
6	-	-	-	Beton	-	Natuurlijk	-	-	-	-	-	-	-

Symbolen

Symbol	Gebouw	Omschrijving	Aantal	Inhoud	Vermeden	Vermeden
1 GRONDSTOFFEN PRODUCTEN						
Subtotaal 1.700						
1.2 Milieuprestatie						
Subtotaal -						
1	4	Oplagst opsluiter (n. sl.)	1	20 m³	-	-
1	4	Oplagst zuurmiddelen	1	950 L	-	-
1	1	Ontsmettings-/aestrijgingsmiddelen	1	2405 kg/L	-	-
Subtotaal 1.700						
1	1	Kroonkast	1	10 kg/L	0,200	0,200
1	1	Mechanische koeling	1	-	1,500	1,500
Subtotaal -						
1.3 Afbouwen/bouwen						
2	1, 4	Mengpomp (n. sl.)	3	10 ton	-	-
3	1	Mengpomp (n. sl.)	1	4 ton	-	-
Subtotaal 259,770						
2.1 Verkeers						
Subtotaal 2,500						
4	4	Mest-/omzuur	9	4 630	-	-
1	1	Verlichter	1	820	2,500	2,500
Subtotaal 62,000						
2.2 Verkeersvoorzieningen						
Subtotaal 172,000						
5	1	Tractor	1	-	50,000	50,000
1	1	Neostroomoprichter 150 kVA	1	-	-	-
3	3	Grasmater (op draai)	1	-	12,000	12,000
Subtotaal 172,000						
2.3 Verkeersvoorzieningen						
Subtotaal 172,000						
1	1	Comp.-kast HR	3	80 L	32,000	96,000
1	1	Brander t.b.v. hogedrukreiniger	1	100 L	76,000	76,000
Subtotaal 232,770						
2.4 Overig						
Subtotaal -						
4.1 Brandveiligheid						
Subtotaal -						
1	1	Brandlaser	5	12 kg	-	-
Totaal 261,470						

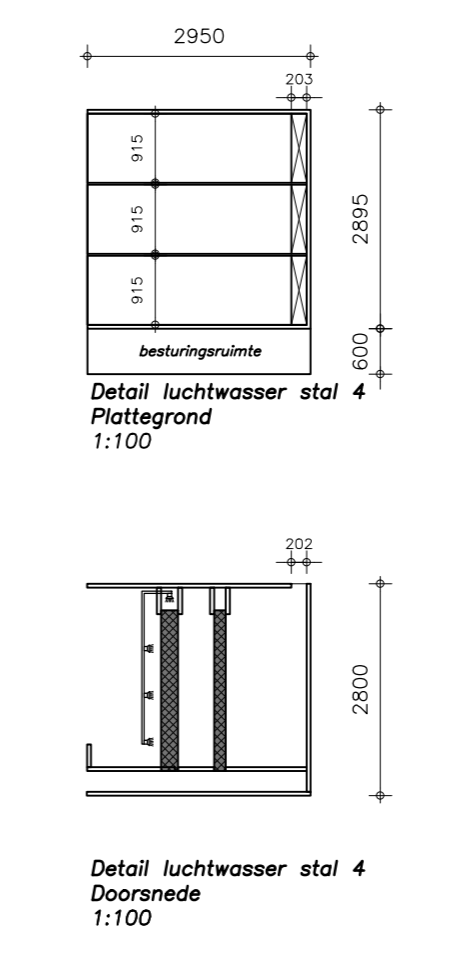
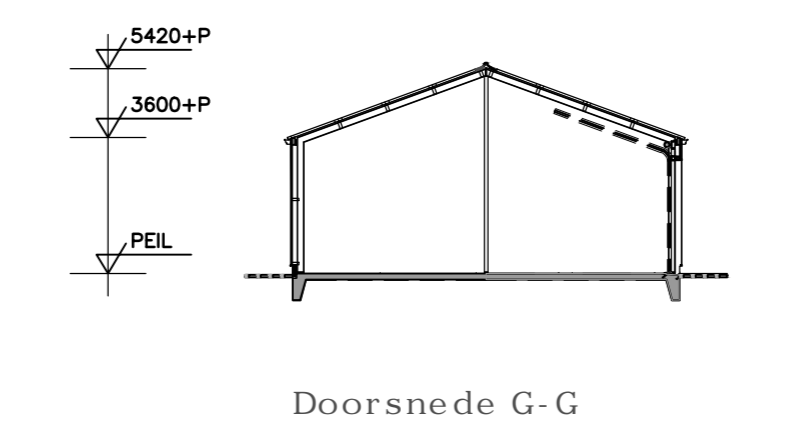
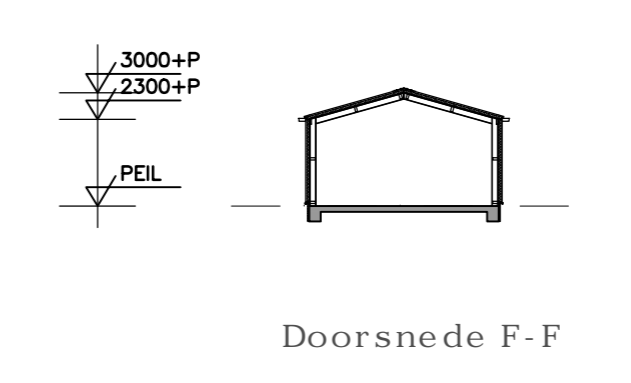
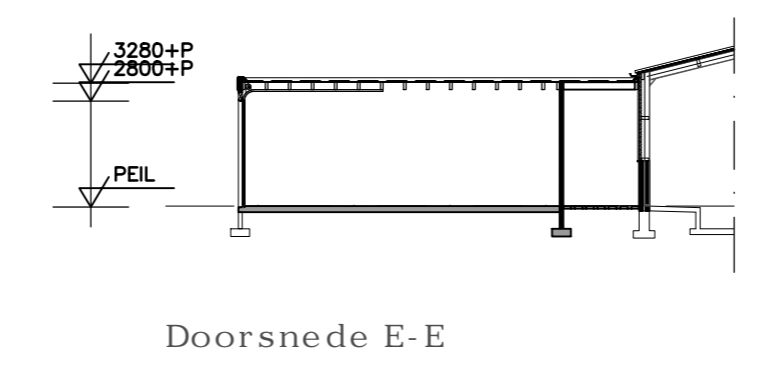
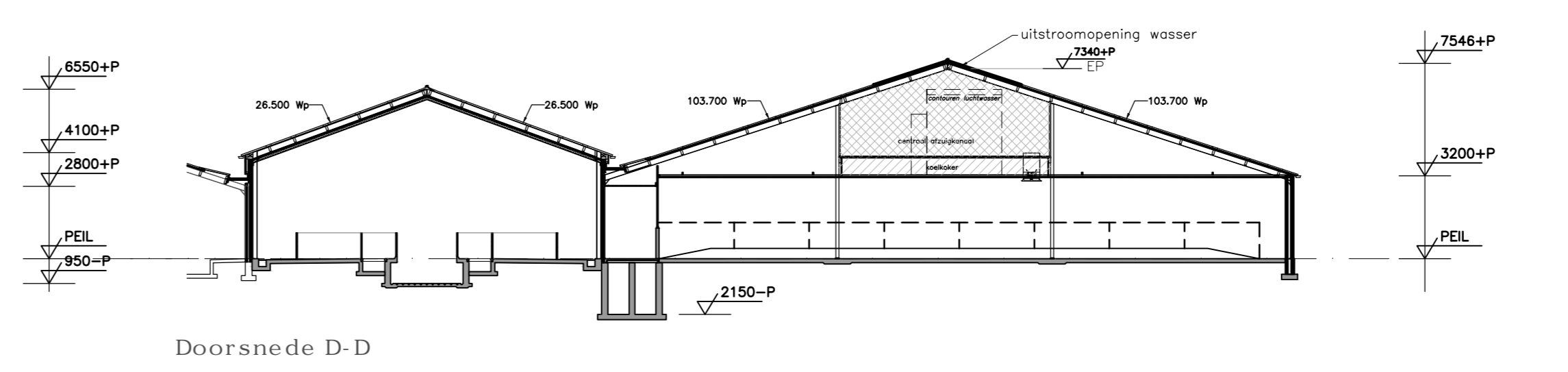
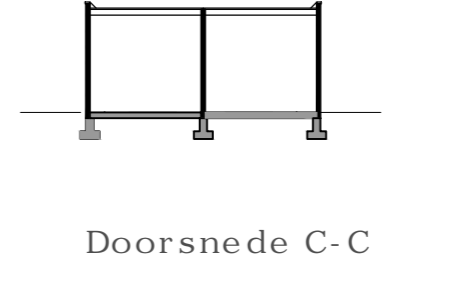
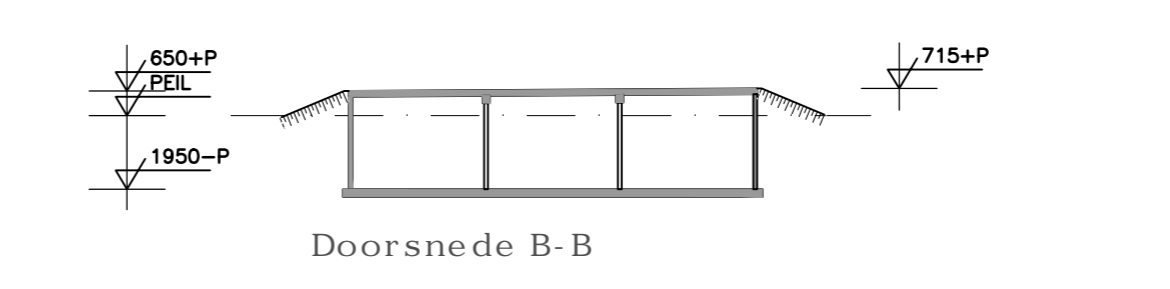
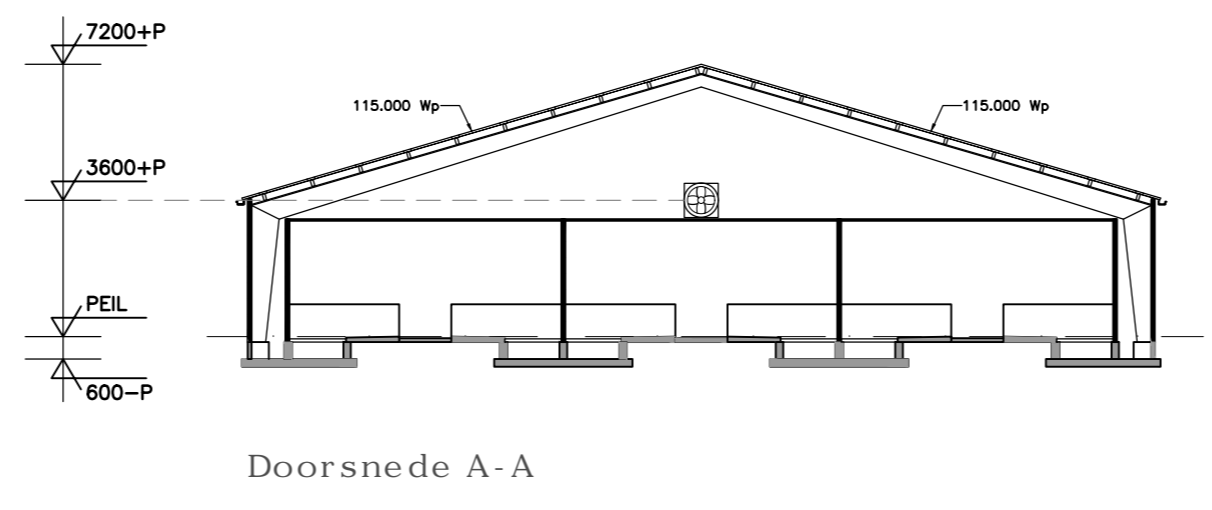
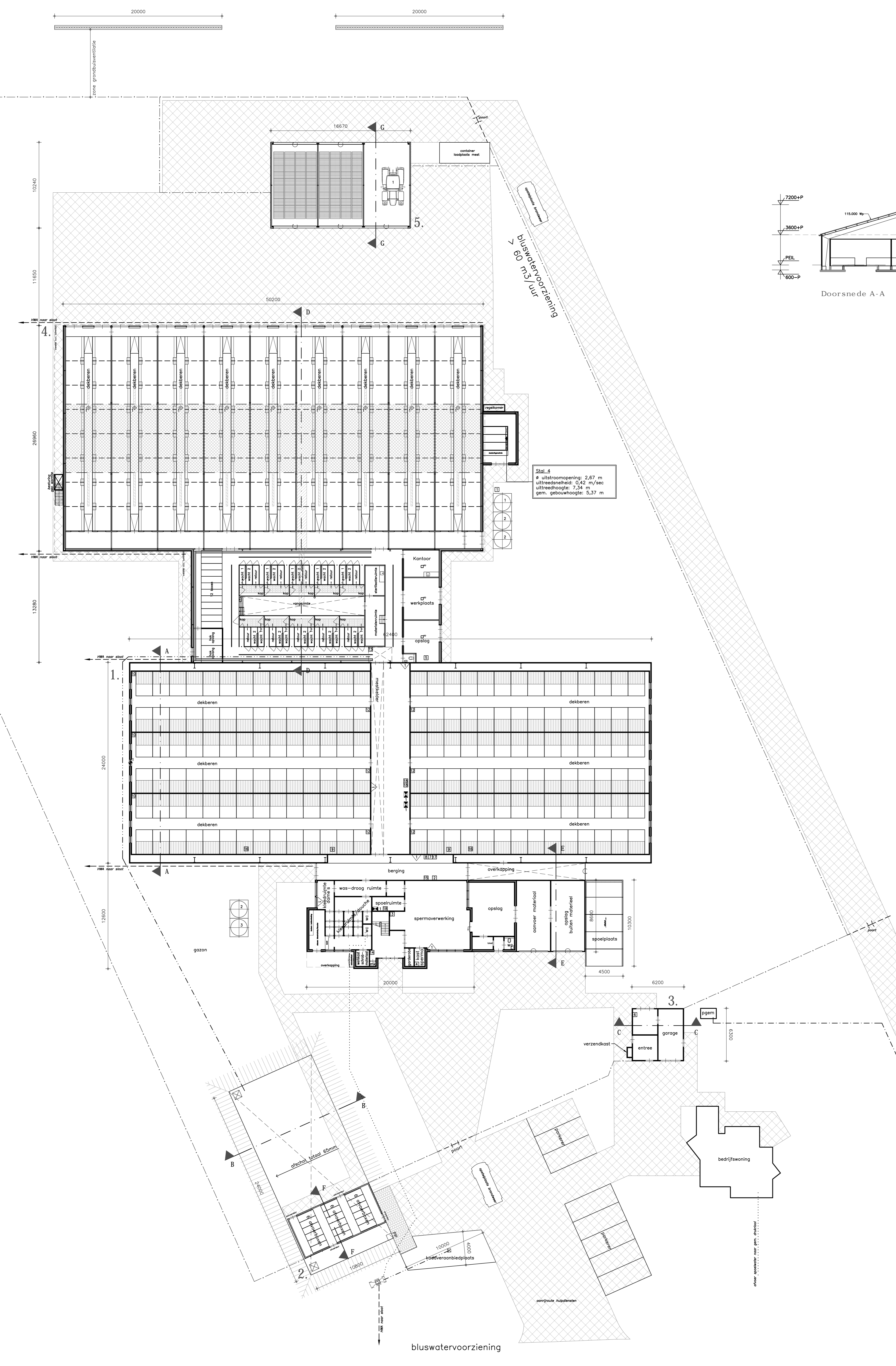

Situatie

Gemeente: | Lierden
 Reeks: | O
 Nummer: | 726, 1086
 Schaal: | 1 : 1000

De aanvraag: | 681

Aanvraag omgevingsvergunning

www.dlvadvies.nl

Situatie Inrichtingstekening Aanvraag omgevingsvergunning, activiteit mbo Plaatsnaam, doornamen en situatie	Schaal: 1:200 Formaat: A0	Datum: 18-04-2018 HNB 11-07-2018 HNB 24-07-2018 HNB 08-11-2018 HNB 18-11-2018 HNB
--	------------------------------	---

Opdrachtgever: Topco Groep BV AM varen KJ Nedertad BV Postbus 911 5268 LT Helvoert Telefoon: 0411-648620 E-mail: info@varkens.nl	DLV Advies Postbus 511 5400 AM Uden Telefoon: 0413-308608 E-mail: info@dlvadvies.nl	Datum: 18-04-2018 HNB 11-07-2018 HNB 24-07-2018 HNB 08-11-2018 HNB 18-11-2018 HNB
---	---	---

Bouwcode: 212000052
 4032 NT Ommeren
 Projectcode: 18-0300502
 E-mail: G.schoneveld@dlvadvies.nl
 Architect: Ing. G.N. Schoneveld
 Tekenaar: G.schoneveld@dlvadvies.nl
 M10